

3x $\phi 8$

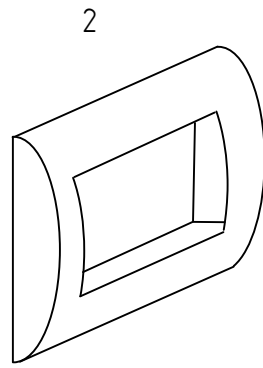

BIO-01B, BIO-01S
BIO-02B, BIO-02S

1

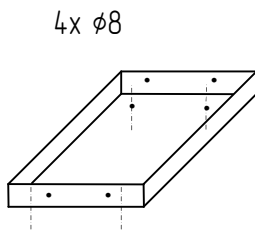

2

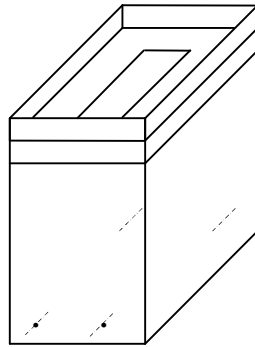

4x M6

3

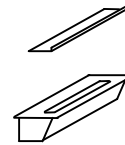

BIO-08, BIO-08B

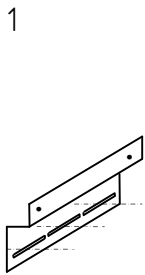

3x $\phi 8$

2

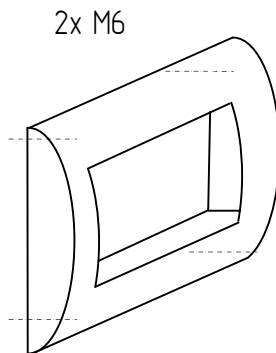

2x M8

3

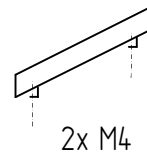

2x M4

4

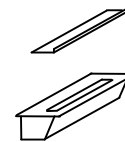

BIO-03, BIO-03B, BIO-03S

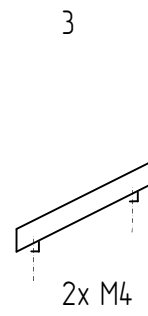
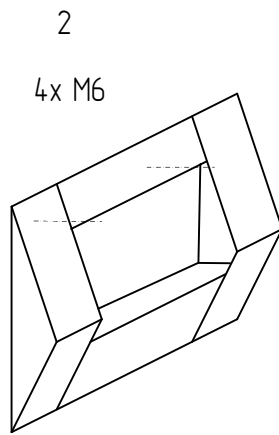
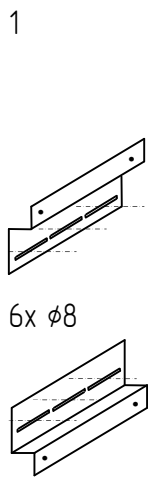

BIO-05, BIO-05B

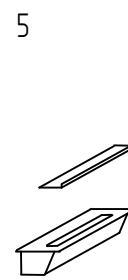
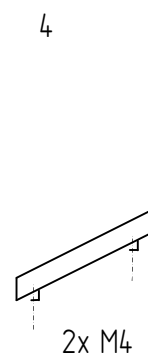
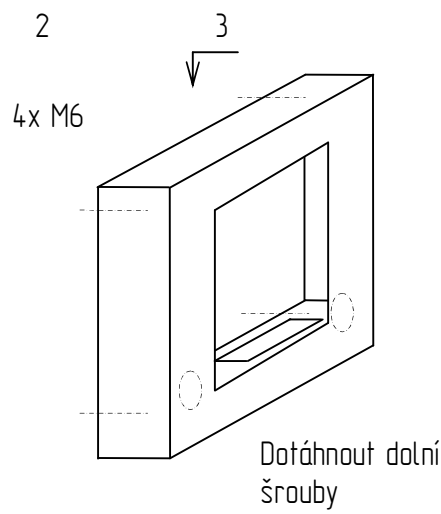
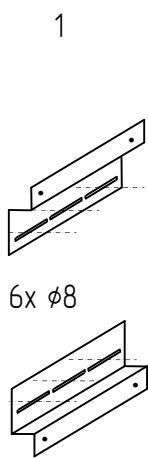

AF-23

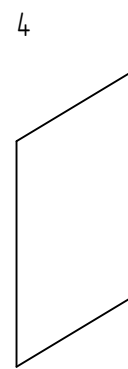
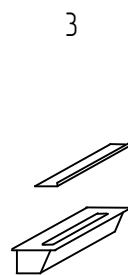
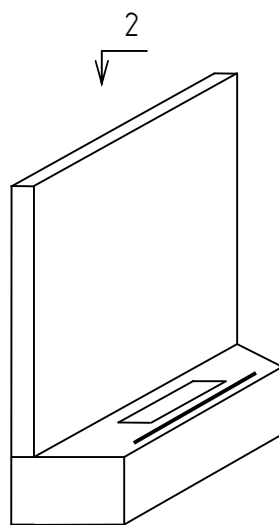
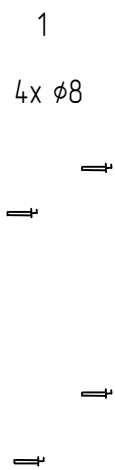

DaVinci

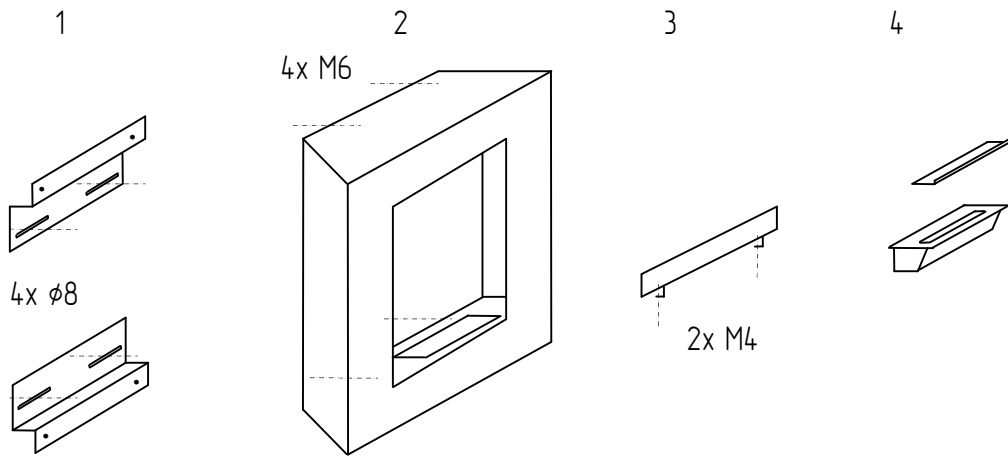

AF-02, AF-02B, AF-02S

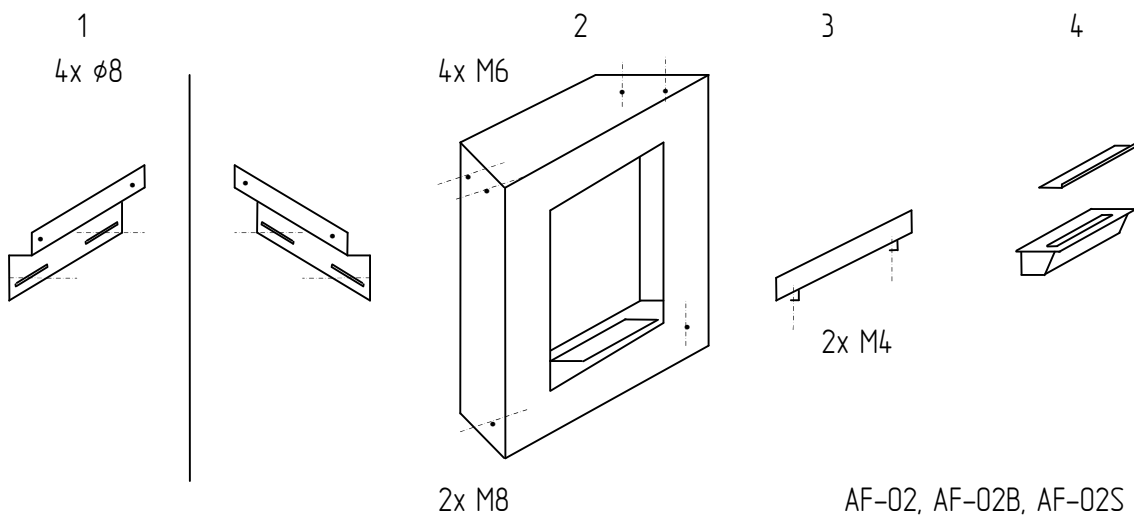

AF-02, AF-02B, AF-02S